

# Section 11

## Manufacturing Equipment

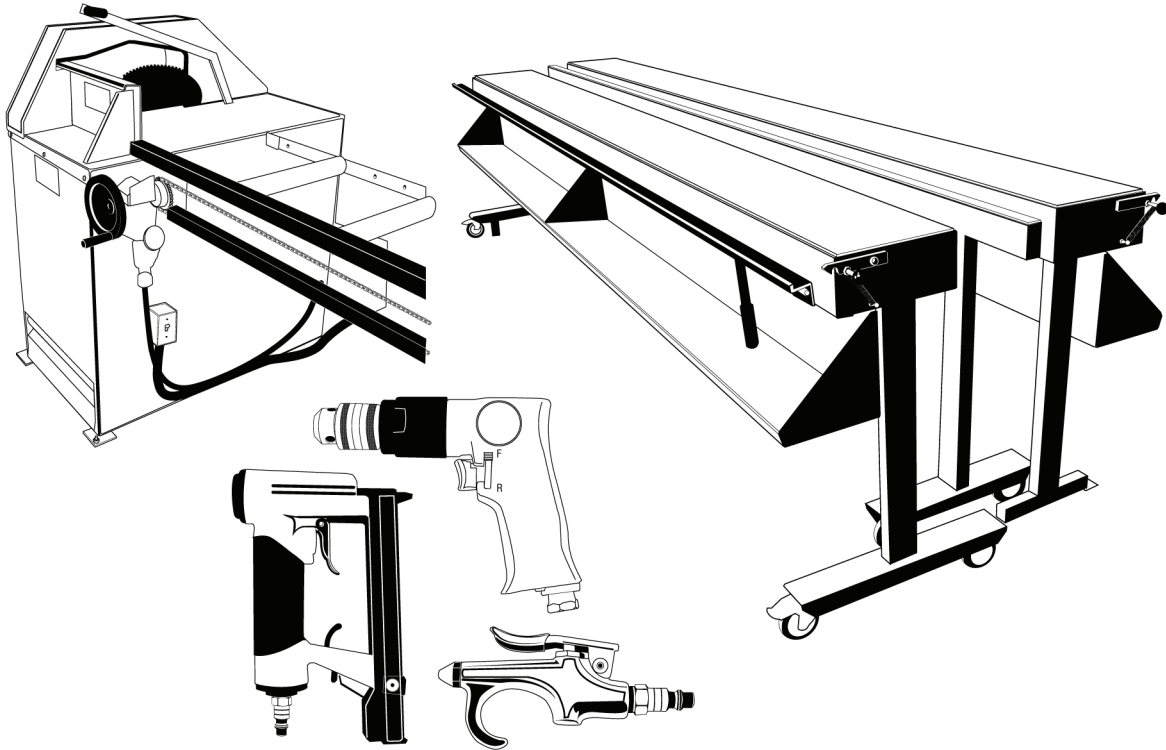

### **Endlocking Bench**

Specially crafted table that aides in curtain assembly. Expandable table allows variance in curtain sizes, with additional rolling center support to prevent sagging in larger curtains.

### **Saw and Blades**

Saw for accurate cutting of rolling shutter profiles and box covers. Designed for high precision and burr free cut. Feeding tables with electronic or manual read out available.

### **Pneumatic Tools**

Recommended dependable tools for rolling shutter assembly.

# MANUFACTURING EQUIPMENT

## Endlocking Bench ( Manual )

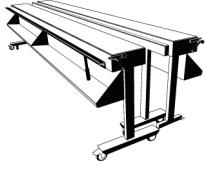
	Part Number	Description	Unit	Note
	9506-ACCE-00-ST	Extendable - Complete with 2 Safety Rails Each 3 mtr	PC	!

## Saws RPS600 Cross-Cut Saw - Manual Read Out 3x220v 60hz with 2 Roller Beds, 4mtr and 5mtr

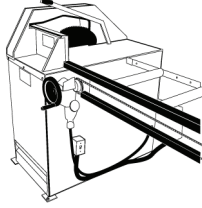
	Part Number	Description	Unit	Note
	9509-ACCE-00-ST	Manual Measuring Device, Left Or Right Stop Custom Length of Tables Available	PC	!

## Saws RPS600 Cross-Cut Saw - Electronic Read Out 3x220v 60hz With 2 Roller Beds, 4mtr and 5mtr

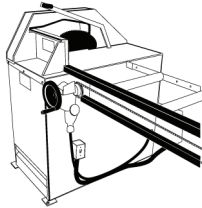
	Part Number	Description	Unit	Note
	9508-ACCE-00-ST	Electronic Measuring Device, Left Or Right Stop Custom Length of Tables Available	PC	!

\* - Typically ships within 3 days  
 N - New item  
 ! - Special order item

# MANUFACTURING EQUIPMENT

## Saw Blade For Rps600 Cross-Cut Saw

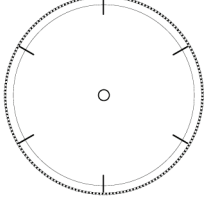
	Part Number	Description	Unit	Note
	9515-ACCE-00-ST	Saw Blade 500 mm x 4.6 mm x 30 mm (19.68")	PC	!
	9516-ACCE-00-ST	Saw Blade 600 mm x 4.6 mm x 30 mm (23.62")	PC	!

## Pneumatic Tools

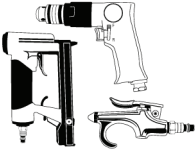
	Part Number	Description	Unit	Note
	9500-ACCE-00-ST	Pneumatic Staple Gun (For 3 mm, 4 mm, & 6 mm Staples)	PC	!
	9501-ACCE-00-ST	Pneumatic Drill (For removing foam from foam filled aluminum profiles)	PC	!
	9503-ACCE-00-ST	Pneumatic Air Blower	PC	!

## Locking Tongs for RLL3 & RLL4

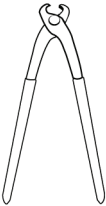
	Part Number	Description	Unit	Note
	9502-ACCE-00-ST	Locking Tongs (For RLL-3 & RLL-4 Base Slat)	PC	!

## Staples ( Rust-Proof ) 10,000/Per Box

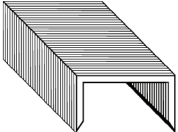
	Part Number	Description	Unit	Note
	9425-ACCE-14-ST	3mm For CD - 90 and CD-100	BX	
	9426-ACCE-14-ST	4mm For A - 150 and A -180	BX	
	9427-ACCE-14-ST	6mm For A - 200 and A -240	BX	

\* - Typically ships within 3 days  
 N - New item  
 ! - Special order item