

# Section 2

## Rails & Accessories

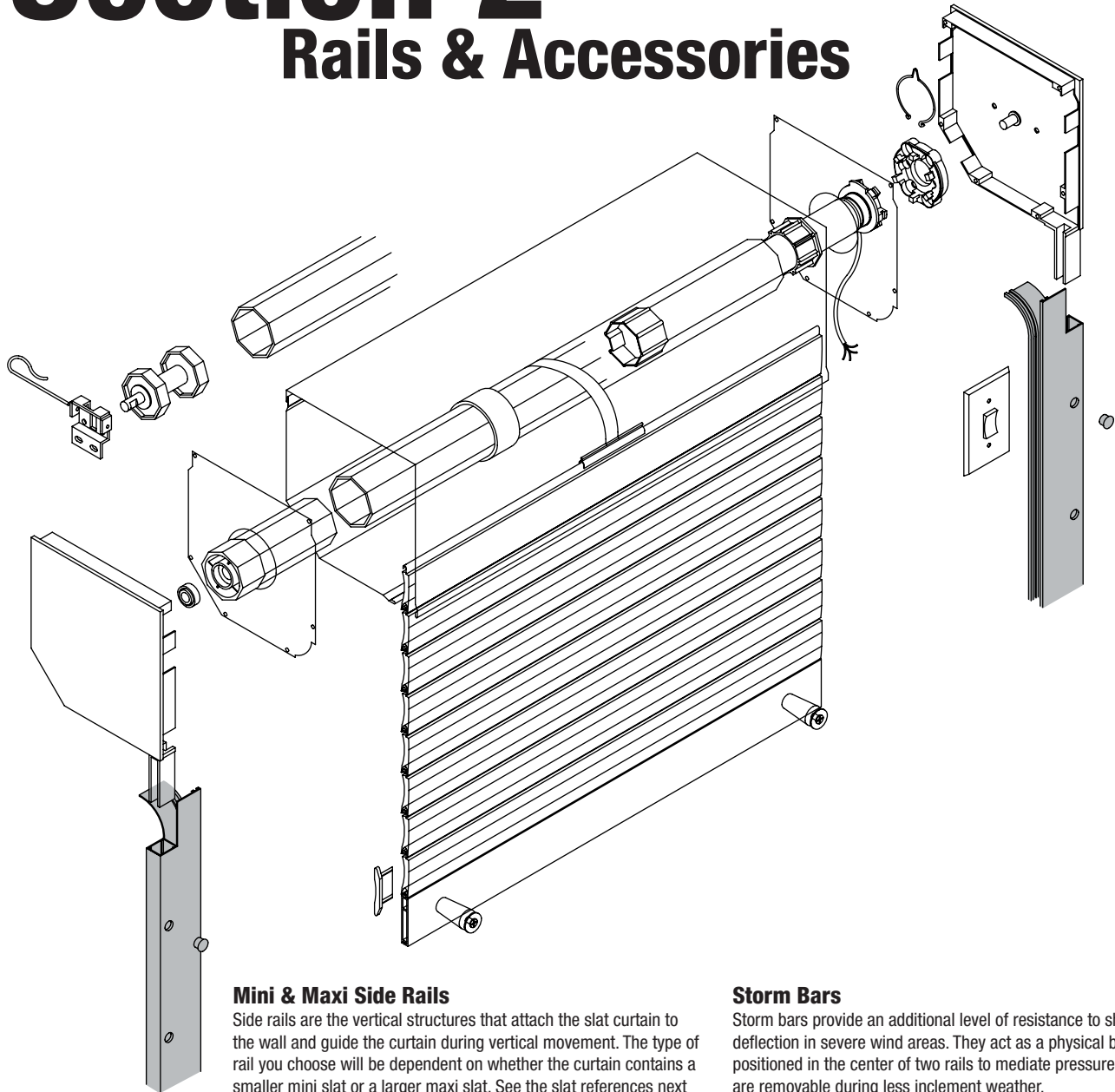

### Mini & Maxi Side Rails

Side rails are the vertical structures that attach the slat curtain to the wall and guide the curtain during vertical movement. The type of rail you choose will be dependent on whether the curtain contains a smaller mini slat or a larger maxi slat. See the slat references next to each part for more information on which rail is right for a given shutter.

### End Retention Side Rails

Choose end retention side rails when high security or severe weather protection is necessary. These rails have an additional extrusion that locks slats into the rail, preventing pull-out under high pressure. Note that a special end retention side lock and slat is required.

### Aluminum Angles

Angles provide a resting point for shutters when an opening lacks a sill or stopping point.

### Notice about Colors

If color is not available, it can be obtained through custom painting. Minimum paint charge of \$150 per color applies.

### Storm Bars

Storm bars provide an additional level of resistance to shutter deflection in severe wind areas. They act as a physical brace that is positioned in the center of two rails to mediate pressure. Storm bars are removable during less inclement weather.

### Build Out

Extra material used when a shutter must clear any obstruction such as a window frame. Select build out materials in conjunction with the size of rail used and the clearance away from the wall required.

# MAXI SIDE RAILS

## Maxi Side Rails 63 mm x 27 mm (2.50" x 1.06") - Fits all Maxi Slats

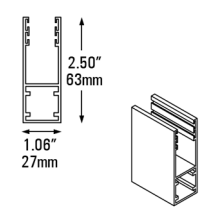
	Part Number	Description	Color	Unit	Note
		2105-RAIL-02-AL	"A" Type	Anodized Silver	FT
	2110-RAIL-04-AL	"A" Type	Cream	FT	*
	2112-RAIL-06-AL	"A" Type	White	FT	*
	2115-RAIL-27-AL	"A" Type	Arcona Beige	FT	*
	2120-RAIL-07-AL	"A" Type	Grey	FT	*
	2122-RAIL-14-AL	"A" Type	Metallic	FT	*
	2125-RAIL-13-AL	"A" Type	Light Beige	FT	*
	2126-RAIL-19-AL	"A" Type	Bronze	FT	*
	2127-RAIL-22-AL	"A" Type	Dark Brown	FT	*

Sold in 20 FT Lengths

## Maxi High Security Side Rails 76 mm X 28 mm (3.00" X 1.12") - Fits all Maxi Slats and Large Leg End Cap

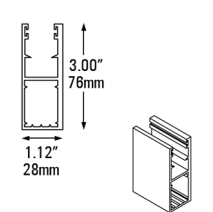
	Part Number	Description	Color	Unit	Note
		2193-RAIL-14-AL	"A" Type for MAXI side/end caps	Metallic	FT
	2194-RAIL-02-AL	"A" Type for MAXI side/end caps	Anodized Silver	FT	
	2196-RAIL-04-AL	"A" Type for MAXI side/end caps	Cream	FT	
	2198-RAIL-06-AL	"A" Type for MAXI side/end caps	White	FT	
	2199-RAIL-07-AL	"A" Type for MAXI side/end caps	Grey	FT	
	2200-RAIL-27-AL	"A" Type for MAXI side/end caps	Arcona Beige	FT	
	2201-RAIL-13-AL	"A" Type for MAXI side/end caps	Light Beige	FT	
	2202-RAIL-19-AL	"A" Type for MAXI side/end caps	Bronze	FT	
	2203-RAIL-22-AL	"A" Type for MAXI side/end caps	Dark Brown	FT	

Sold in 20 FT Lengths

## Maxi Rails 76 mm X 23 mm (3.00" X 1.06") - Fits all Maxi Slats

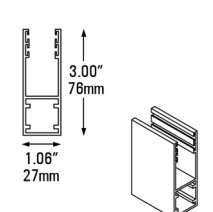
	Part Number	Description	Color	Unit	Note
		2180-RAIL-02-AL	"A" Type	Anodized Silver	FT
	2182-RAIL-04-AL	"A" Type	Cream	FT	
	2184-RAIL-06-AL	"A" Type	White	FT	
	2186-RAIL-07-AL	"A" Type	Grey	FT	
	2187-RAIL-27-AL	"A" Type	Arcona Beige	FT	
	2188-RAIL-13-AL	"A" Type	Light Beige	FT	
	2189-RAIL-14-AL	"A" Type	Metallic	FT	N
	2190-RAIL-19-AL	"A" Type	Bronze	FT	
	2192-RAIL-22-AL	"A" Type	Dark Brown	FT	

Sold in 20 FT Lengths

## Maxi Side Rails 95 mm x 27 mm (3.75" x 1.06") - Fits all Maxi Slats

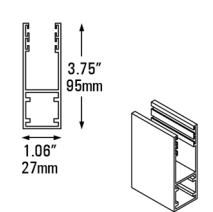
	Part Number	Description	Color	Unit	Note
		2141-RAIL-04-AL	"A" Type	Cream	FT
	2142-RAIL-06-AL	"A" Type	White	FT	
	2144-RAIL-07-AL	"A" Type	Grey	FT	
	2146-RAIL-13-AL	"A" Type	Light Beige	FT	
	2147-RAIL-19-AL	"A" Type	Bronze	FT	
	2148-RAIL-22-AL	"A" Type	Dark Brown	FT	

Sold in 20 FT Lengths

Available in Limited Quantities

\* - Typically ships within 3 days  
 N - New item  
 ! - Special order item

# MAXI SIDE RAILS

## Center Rails for Maxi Slats (Mullion) - Fits All Maxi Slats

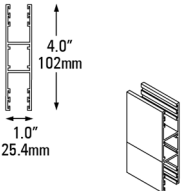
	Part Number	Description	Color	Unit	Note
		2207-MULL-04-AL	Mullion	Cream	FT
	2210-MULL-06-AL	Mullion	White	FT	
	2213-MULL-13-AL	Mullion	Light Beige	FT	
	2220-MULL-22-AL	Mullion	Dark Brown	FT	

Sold in 20 FT Lengths

## Maxi Side Rails 35 mm x 28 mm(1.36" x 1.10") - Fits all Maxi Slats

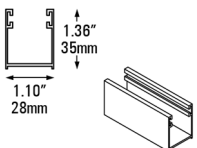
	Part Number	Description	Color	Unit	Note
		2150-RAIL-06-AL	"U" Type	White	FT

Sold in 20 FT Lengths

## Rail Pack for Single Wall Slats

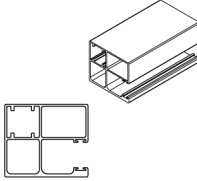
	Part Number	Description	Color	Unit	Note
		2221-RAIL-22-AL		Dk. Brown	FT
	2222-RAIL-14-AL		Metallic	FT	
	2224-RAIL-04-AL		Cream	FT	
	2225-RAIL-06-AL		White	FT	
	2226-RAIL-07-AL		Grey	FT	
	2227-RAIL-13-AL		Beige	FT	
	2228-RAIL-19-AL		Bronze	FT	
	2229-RAIL-27-AL		Arcona Beige	FT	

Sold in 20 FT Lengths

\* - Typically ships within 3 days  
 N - New item  
 ! - Special order item

# MINI SIDE RAILS

## Mini Side Rails 53 mm X 22 mm (2.09" X 0.86") - Fits all Mini Slats

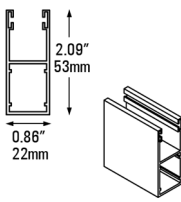
	Part Number	Description	Color	Unit	Note
		2005-RAIL-02-AL	"A" Type	Anodized Silver	FT
	2006-RAIL-23-AL	"A" Type	Mill Finish	FT	N
	2008-RAIL-04-AL	"A" Type	Cream	FT	*
	2010-RAIL-06-AL	"A" Type	White	FT	*
	2012-RAIL-07-AL	"A" Type	Grey	FT	*
	2015-RAIL-27-AL	"A" Type	Arcona Beige	FT	*
	2017-RAIL-13-AL	"A" Type	Light Beige	FT	*
	2018-RAIL-14-AL	"A" Type	Metallic	FT	*
	2020-RAIL-19-AL	"A" Type	Bronze	FT	*
	2030-RAIL-22-AL	"A" Type	Dark Brown	FT	*

Sold in 20 FT Lengths

## Mini Side Rails 64 mm X 22 mm (2.50" X 0.86") - Fits all Mini Slats

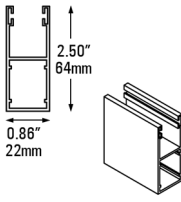
	Part Number	Description	Color	Unit	Note
		2060-RAIL-02-AL	"A" Type	Anodized Silver	FT
	2062-RAIL-04-AL	"A" Type	Cream	FT	*
	2064-RAIL-06-AL	"A" Type	White	FT	*
	2065-RAIL-14-AL	"A" Type	Metallic	FT	*
	2066-RAIL-07-AL	"A" Type	Grey	FT	*
	2067-RAIL-27-AL	"A" Type	Arcona Beige	FT	*
	2068-RAIL-13-AL	"A" Type	Light Beige	FT	*
	2069-RAIL-19-AL	"A" Type	Bronze	FT	*
	2070-RAIL-22-AL	"A" Type	Dark Brown	FT	*

Sold in 20 FT Lengths

## Center Rails For Mini Slats (Mullion) - Fits all Mini Slats

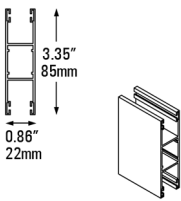
	Part Number	Description	Color	Unit	Note
		2080-MULL-04-AL	Mullion	Cream	FT
	2081-MULL-06-AL	Mullion	White	FT	
	2084-MULL-07-AL	Mullion	Grey	FT	
	2085-MULL-13-AL	Mullion	Light Beige	FT	
	2090-MULL-22-AL	Mullion	Dark Brown	FT	

Sold in 20 FT Lengths

\* - Typically ships within 3 days  
 N - New item  
 ! - Special order item

# END RETENTION RAILS

## Maxi End Retention Side Rails 76 mm X 28 mm (3.00" X 1.11") - Fits Apex A55, RLL55-X, & RLL-59

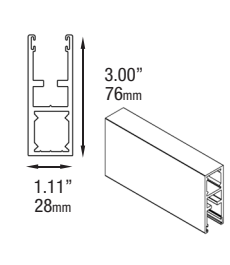
	Part Number	Description	Color	Unit	Note
		2296-RAIL-23-AL	End Retention f/ Small Leg	Mill Finish	FT
	2298-RAIL-14-AL	End Retention f/ Small Leg	Metallic	FT	
	2299-RAIL-02-AL	End Retention f/ Small Leg	Anodized Silver	FT	
	2300-RAIL-04-AL	End Retention f/ Small Leg	Cream	FT	
	2301-RAIL-06-AL	End Retention f/ Small Leg	White	FT	
	2302-RAIL-07-AL	End Retention f/ Small Leg	Grey	FT	
	2303-RAIL-13-AL	End Retention f/ Small Leg	Light Beige	FT	
	2304-RAIL-19-AL	End Retention f/ Small Leg	Bronze	FT	
	2305-RAIL-22-AL	End Retention f/ Small Leg	Dark Brown	FT	

Sold in 20 ft Lengths

## Maxi End Retention Side Rails 76 mm X 28 mm (3.00" X 1.11") - Fits Apex A55, RLL55-X, & RLL59 / Maxi Leg End Cap

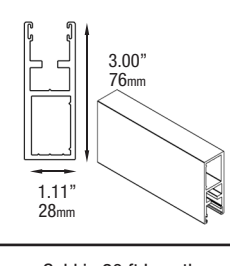
	Part Number	Description	Color	Unit	Note
		2297-RAIL-14-AL	End Retention f/ Large Leg	Metallic	FT
	2313-RAIL-27-AL	End Retention f/ Large Leg	Arcona Beige	FT	N
	2314-RAIL-02-AL	End Retention f/ Large Leg	Anodized Silver	FT	
	2315-RAIL-04-AL	End Retention f/ Large Leg	Cream	FT	
	2316-RAIL-06-AL	End Retention f/ Large Leg	White	FT	
	2317-RAIL-07-AL	End Retention f/ Large Leg	Grey	FT	
	2318-RAIL-13-AL	End Retention f/ Large Leg	Light Beige	FT	
	2319-RAIL-19-AL	End Retention f/ Large Leg	Bronze	FT	
	2320-RAIL-22-AL	End Retention f/ Large Leg	Dark Brown	FT	N
	2321-RAIL-23-AL	End Retention f/ Large Leg	Mill Finish	FT	N

Sold in 20 ft Lengths

## Maxi End Retention Side Rails 89 mm X 28 mm (3.50" X 1.11") - Fits Apex A55, RLL55-X, & RLL59

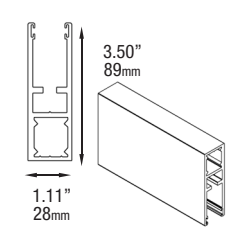
	Part Number	Description	Color	Unit	Note
		2306-RAIL-04-AL	End Retention f/ Small Leg	Cream	FT
	2307-RAIL-06-AL	End Retention f/ Small Leg	White	FT	
	2308-RAIL-07-AL	End Retention f/ Small Leg	Grey	FT	
	2309-RAIL-13-AL	End Retention f/ Small Leg	Light Beige	FT	
	2310-RAIL-19-AL	End Retention f/ Small Leg	Bronze	FT	
	2312-RAIL-02-AL	End Retention f/ Small Leg	Anodized Silver	FT	
	2333-RAIL-14-AL	End Retention f/ Small Leg	Metallic	FT	N

Sold in 20 ft Lengths

## Maxi End Retention Side Rails 89 mm X 28 mm (3.50" X 1.11") - Fits Apex A55, RLL55-X, & RLL59 / Maxi Leg End Cap

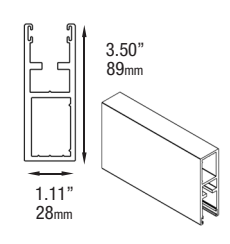
	Part Number	Description	Color	Unit	Note
		2324-RAIL-02-AL	End Retention f/ Large Leg	Anodized Silver	FT
	2325-RAIL-04-AL	End Retention f/ Large Leg	Cream	FT	
	2326-RAIL-06-AL	End Retention f/ Large Leg	White	FT	
	2327-RAIL-07-AL	End Retention f/ Large Leg	Grey	FT	
	2328-RAIL-13-AL	End Retention f/ Large Leg	Light Beige	FT	
	2329-RAIL-19-AL	End Retention f/ Large Leg	Bronze	FT	
	2332-RAIL-14-AL	End Retention f/ Large Leg	Metallic	FT	N
	2334-RAIL-23-AL	End Retention f/ Large Leg	Mill Finish	FT	N

Sold in 20 ft Lengths

\* - Typically ships within 3 days  
 N - New item  
 ! - Special order item

# ALUMINUM ANGLES

## Aluminum Angle: Length = 1.0", Height = 1.25" & Wall Thickness = 0.125"

	Part Number	Description	Color	Unit	Note
	2507-ANGL-14-AL	Bottom Sill	Metallic	FT	*
	2508-ANGL-04-AL	Bottom Sill	Cream	FT	*
	2510-ANGL-06-AL	Bottom Sill	White	FT	*
	2511-ANGL-07-AL	Bottom Sill	Grey	FT	*
	2514-ANGL-13-AL	Bottom Sill	Light Beige	FT	*
	2516-ANGL-19-AL	Bottom Sill	Bronze	FT	*
	2517-ANGL-27-AL	Bottom Sill	Arcona Beige	FT	*
	2518-ANGL-22-AL	Bottom Sill	Dark Brown	FT	*

Sold in 20 ft Lengths

## Aluminum Angle: Length = 1.0", Height = 2.0" & Wall Thickness = 0.125"

	Part Number	Description	Color	Unit	Note
	2534-ANGL-07-AL	Bottom Sill	Grey	FT	
	2535-ANGL-06-AL	Bottom Sill	White	FT	
	2536-ANGL-13-AL	Bottom Sill	Light Beige	FT	
	2537-ANGL-04-AL	Bottom Sill	Cream	FT	
	2538-ANGL-27-AL	Bottom Sill	Arcona Beige	FT	

Sold in 20 ft Lengths

All other Rollac standard colors are available upon request.

## Aluminum Angle: Length = 2.00", Height = 2.00" Wall Thickness = 0.125"

	Part Number	Description	Color	Unit	Note
	2541-ANGL-14-AL	Bottom Sill	Metallic	FT	N
	2542-ANGL-04-AL	Bottom Sill	Cream	FT	
	2543-ANGL-06-AL	Bottom Sill	White	FT	
	2544-ANGL-07-AL	Bottom Sill	Grey	FT	
	2545-ANGL-13-AL	Bottom Sill	Light Beige	FT	
	2546-ANGL-19-AL	Bottom Sill	Bronze	FT	
	2547-ANGL-22-AL	Bottom Sill	Dark Brown	FT	

Sold in 20 ft Lengths

All other Rollac standard colors are available upon request.

## Aluminum Angle: Length = 2.00", Height = 3.00" Wall Thickness = 0.125"

	Part Number	Description	Color	Unit	Note
	2539-ANGL-13-AL	Bottom Sill	Light Beige	FT	
	2540-ANGL-06-AL	Bottom Sill	White	FT	
	2549-ANGL-19-AL	Bottom Sill	Bronze	FT	
	2551-ANGL-04-AL	Bottom Sill	Cream	FT	

Sold in 20 ft Lengths

All other Rollac standard colors are available upon request.

\* - Typically ships within 3 days  
 N - New item  
 ! - Special order item

# ALUMINUM ANGLES

## Support Bar: "T" Shape 2" X 2" With Wall Thickness = 0.125"

	Part Number	Description	Color	Unit	Note
	2550-SILL-06-AL	For Use With Mullions	White	FT	

Sold in 20 ft Lengths

## Aluminum U-Channel 1.03" X 0.75"

	Part Number	Description	Color	Unit	Note
	2600-SILL-04-AL	Bottom Sill	Cream	FT	
	2601-SILL-27-AL	Bottom Sill	Arcona Beige	FT	
	2602-SILL-06-AL	Bottom Sill	White	FT	
	2603-SILL-14-AL	Bottom Sill	Metallic	FT	
	2604-SILL-07-AL	Bottom Sill	Grey	FT	
	2605-SILL-13-AL	Bottom Sill	Light Beige	FT	
	2607-SILL-19-AL	Bottom Sill	Bronze	FT	
	2610-SILL-22-AL	Bottom Sill	Dark Brown	FT	

Sold in 20 ft Lengths

\* - Typically ships within 3 days  
 N - New item  
 ! - Special order item

# PLUG BUTTONS

## Plug Buttons - 0.390"

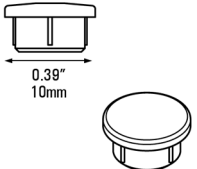
	Part Number	Description	Color	Unit	Note
		2815-PLUG-06-PL 2818-PLUG-13-PL	10.0 mm / 0.390" 10.0 mm / 0.390"	White Light Beige	PC PC

## Plug Buttons - 0.50"

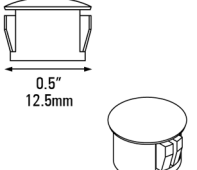
	Part Number	Description	Color	Unit	Note
		2840-PLUG-14-PL 2841-PLUG-04-PL 2842-PLUG-06-PL 2843-PLUG-07-PL 2844-PLUG-13-PL 2845-PLUG-19-PL 2846-PLUG-22-PL 2847-PLUG-27-PL	12.5 mm / 0.500" 12.5 mm / 0.500" 12.5 mm / 0.500" 12.5 mm / 0.500" 12.5 mm / 0.500" 12.5 mm / 0.500" 12.5 mm / 0.500" 12.5 mm / 0.500"	Metallic Cream White Grey Light Beige Bronze Dark Brown Arcona Beige	PC PC PC PC PC PC PC PC

## Plug Buttons - 0.625"

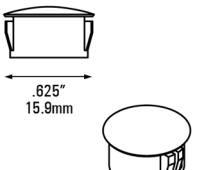
	Part Number	Description	Color	Unit	Note
		2849-PLUG-04-PL 2850-PLUG-06-PL 2851-PLUG-07-PL 2852-PLUG-13-PL 2853-PLUG-19-PL 2854-PLUG-22-PL 2856-PLUG-27-PL 2857-PLUG-14-PL	15.9 mm / 0.625" 15.9 mm / 0.625" 15.9 mm / 0.625" 15.9 mm / 0.625" 15.9 mm / 0.625" 15.9 mm / 0.625" 15.9 mm / 0.625" 15.9 mm / 0.625"	Cream White Grey Light Beige Bronze Dark Brown Arcona Beige Metallic	PC PC PC PC PC PC PC PC

## Flat Buttons

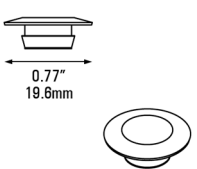
	Part Number	Description	Color	Unit	Note
		2830-PLUG-06-PL 2832-PLUG-19-PL	10.0 mm 19.5mm (0.39"x0.77") 10.0 mm 19.5mm (0.39"x0.77")	White Bronze	PC PC

## Plug Button - 0.750"

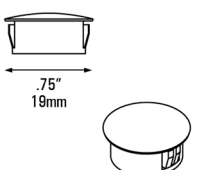
	Part Number	Description	Color	Unit	Note
		2848-PLUG-06-PL	19.0 mm / 0.750"	White	PC

\* - Typically ships within 3 days  
N - New item  
! - Special order item



# ACCESSORIES

## Spray Paint

	Part Number	Description	Color	Unit	Note
	9280-ACCE-PAINT	Spray Acrylic Enamel (12 OZ. Can)	Cream (04)	PC	
	9281-ACCE-PAINT	Spray Acrylic Enamel (12 OZ. Can)	White (06)	PC	
	9282-ACCE-PAINT	Spray Acrylic Enamel (12 OZ. Can)	Lt. Grey (07)	PC	
	9283-ACCE-PAINT	Spray Acrylic Enamel (12 OZ. Can)	Lt. Beige (13)	PC	
	9284-ACCE-PAINT	Spray Acrylic Enamel (12 OZ. Can)	Dark Brown (22)	PC	
	9285-ACCE-PAINT	Spray Acrylic Enamel (12 OZ. Can)	Arcona Beige (27)	PC	
	9312-ACCE-PAINT	Spray Acrylic Enamel (12 OZ. Can)	Med. Bronze (19)	PC	

## Touch Up Paint

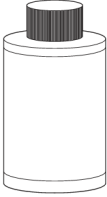
	Part Number	Description	Color	Unit	Note
	9313-ACCE-PAINT	Touch-up Acrylic Enamel (0.6 FL OZ)	Cream (04)	PC	
	9314-ACCE-PAINT	Touch-up Acrylic Enamel (0.6 FL OZ)	White (06)	PC	
	9315-ACCE-PAINT	Touch-up Acrylic Enamel (0.6 FL OZ)	Lt. Grey (07)	PC	
	9316-ACCE-PAINT	Touch-up Acrylic Enamel (0.6 FL OZ)	Lt. Beige (13)	PC	
	9317-ACCE-PAINT	Touch-up Acrylic Enamel (0.6 FL OZ)	Bronze (19)	PC	
	9318-ACCE-PAINT	Touch-up Acrylic Enamel (0.6 FL OZ)	Brown (22)	PC	
	9319-ACCE-PAINT	Touch-up Acrylic Enamel (0.6 FL OZ)	Arcona Beige (27)	PC	

## Cleaning Spray For Aluminum ( Alumaslick )

	Part Number	Description	Color	Unit	Note
	9320-ACCE-CLEAN	Lubes, Cleans, Protects Aluminum			PC

## Cap For 2 1/8" Mini Side Rails (Part numbers #2005 - #2030) Bottom Seal

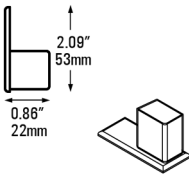
	Part Number	Description	Color	Unit	Note
	2034-RAIL-06-PL	Guide Channel End Cap For A3 (PVC)	White	PR	
	2035-RAIL-19-PL	Guide Channel End Cap For A3 (PVC)	Bronze	PR	

\* - Typically ships within 3 days  
 N - New item  
 ! - Special order item

# STORM BARS

## Storm Bar System Bottom Tongue

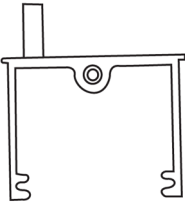
	Part Number	Description	Color	Unit	Note
		STORMB-2.5-CENT	Center, For 2.5" Storm Bar	Millfinish	PC

## Floor Plate - Floor Clips

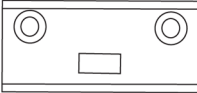
	Part Number	Description	Color	Unit	Note
		STORMB-FLOOR-CL	Floor Plate	Millfinish	PC

## Storm Bar Splitrac 2" Hollow Core

	Part Number	Description	Color	Unit	Note
	STORMB-RLL13-04	2.0" Hollow Core	Cream	FT	
	STORMB-RLL13-06	2.0" Hollow Core	White	FT	
	STORMB-RLL13-07	2.0" Hollow Core	Grey	FT	
	STORMB-RLL13-13	2.0" Hollow Core	Light Beige	FT	
	STORMB-RLL13-19	2.0" Hollow Core	Bronze	FT	
	STORMB-RLL13-22	2.0" Hollow Core	Dark Brown	FT	

Sold in 20 ft Lengths

## Storm Bar Splitrac 2.5" Hollow Core

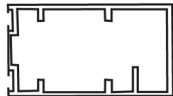
	Part Number	Description	Color	Unit	Note
	STORMB-RLL15-04	2.5" Hollow Core	Cream	FT	
	STORMB-RLL15-06	2.5" Hollow Core	White	FT	
	STORMB-RLL15-07	2.5" Hollow Core	Grey	FT	
	STORMB-RLL15-13	2.5" Hollow Core	Light Beige	FT	
	STORMB-RLL15-19	2.5" Hollow Core	Bronze	FT	
	STORMB-RLL15-22	2.5" Hollow Core	Dark Brown	FT	

Sold in 20 ft Lengths

## Bottom Hood Extrusion

	Part Number	Description	Color	Unit	Note
	STORMB-RLL14-04	Bottom Hood Extrusion	Cream	FT	
	STORMB-RLL14-06	Bottom Hood Extrusion	White	FT	
	STORMB-RLL14-07	Bottom Hood Extrusion	Grey	FT	
	STORMB-RLL14-13	Bottom Hood Extrusion	Light Beige	FT	
	STORMB-RLL14-19	Bottom Hood Extrusion	Bronze	FT	
	STORMB-RLL14-22	Bottom Hood Extrusion	Dark Brown	FT	

Sold in 20 ft Lengths

\* - Typically ships within 3 days  
 N - New item  
 ! - Special order item

# STORM BARS

## I-Beam For Storm Bar

	Part Number	Description	Color	Unit	Note
	STORMB-RLL16-01	I-Beam For 2.5" Hollow Core	Millfinish	FT	
	STORMB-RLL17-01	I-Beam For 2" Hollow Core	Millfinish	FT	

Sold in 20 ft Lengths

## Top Receptor

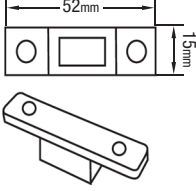
	Part Number	Description	Color	Unit	Note
	STORMB-TOP-REC	Top Receptor	Plastic	PC	

## Spring Assembly Top Connecting Mechanism

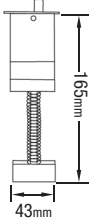
	Part Number	Description	Color	Unit	Note
	STORMB-SPR-CENT	(Center Tongue)		PC	

## Storage Clips

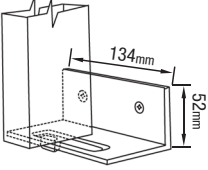
	Part Number	Description	Color	Unit	Note
	STORMB-CLP-06-S	Single 67 mm x 26 mm	White	PC	
	STORMB-CLP-06-D	Double 134 mm x 52 mm	White	PC	

\* - Typically ships within 3 days  
 N - New item  
 ! - Special order item

# BUILD OUT

## Rectangular Tubes - 1.0" x 2.0" x 0.125"

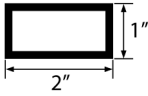
	Part Number	Description	Color	Unit	Note
	9647-TUBE-19-AL	1.0" x 2.0" x 0.125"	Bronze	FT	
	9649-TUBE-04-AL	1.0" x 2.0" x 0.125"	Cream	FT	
	9653-TUBE-06-AL	1.0" x 2.0" x 0.125"	White	FT	
	9654-TUBE-13-AL	1.0" x 2.0" x 0.125"	Light Beige	FT	
	9656-TUBE-23-AL	1.0" x 2.0" x 0.125"	Millfinish	FT	

Sold in 20 ft Lengths

All other Rollac standard colors are available upon request.

## Rectangular Tubes - 1.0" x 3.0" x 0.125"

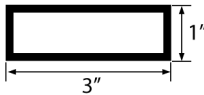
	Part Number	Description	Color	Unit	Note
	9657-TUBE-04-AL	1.0" x 3.0" x 0.125"	Cream	FT	
	9658-TUBE-06-AL	1.0" x 3.0" x 0.125"	White	FT	
	9659-TUBE-07-AL	1.0" x 3.0" x 0.125"	Grey	FT	
	9660-TUBE-13-AL	1.0" x 3.0" x 0.125"	Light Beige	FT	
	9661-TUBE-19-AL	1.0" x 3.0" x 0.125"	Bronze	FT	
	9662-TUBE-22-AL	1.0" x 3.0" x 0.125"	Dark Brown	FT	

Sold in 20 ft Lengths

All other Rollac standard colors are available upon request.

## Rectangular Tubes - 1.0" x 4.0" x 0.125"

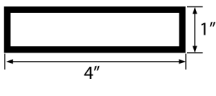
	Part Number	Description	Color	Unit	Note
	9663-TUBE-04-AL	1.0" x 4.0" x 0.125"	Cream	FT	
	9664-TUBE-06-AL	1.0" x 4.0" x 0.125"	White	FT	
	9665-TUBE-07-AL	1.0" x 4.0" x 0.125"	Grey	FT	
	9666-TUBE-13-AL	1.0" x 4.0" x 0.125"	Light Beige	FT	
	9667-TUBE-19-AL	1.0" x 4.0" x 0.125"	Bronze	FT	
	9668-TUBE-22-AL	1.0" x 4.0" x 0.125"	Dark Brown	FT	

Sold in 20 ft Lengths

All other Rollac standard colors are available upon request.

## Rectangular Tubes - 2.0" x 3.0" x 0.125"

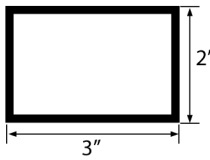
	Part Number	Description	Color	Unit	Note
	9675-TUBE-04-AL	2.0" x 3.0" x 0.125"	Cream	FT	
	9676-TUBE-06-AL	2.0" x 3.0" x 0.125"	White	FT	
	9677-TUBE-07-AL	2.0" x 3.0" x 0.125"	Grey	FT	
	9678-TUBE-13-AL	2.0" x 3.0" x 0.125"	Light Beige	FT	
	9679-TUBE-19-AL	2.0" x 3.0" x 0.125"	Bronze	FT	
	9680-TUBE-22-AL	2.0" x 3.0" x 0.125"	Dark Brown	FT	

Sold in 20 ft Lengths

All other Rollac standard colors are available upon request.

\* - Typically ships within 3 days  
 N - New item  
 ! - Special order item

### Rectangular Tubes - 2.0" x 4.0" x 0.125"

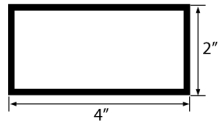
	Part Number	Description	Color	Unit	Note
	9681-TUBE-04-AL	2.0" x 4.0" x 0.125"	Cream	FT	
	9682-TUBE-06-AL	2.0" x 4.0" x 0.125"	White	FT	
	9683-TUBE-07-AL	2.0" x 4.0" x 0.125"	Grey	FT	
	9684-TUBE-13-AL	2.0" x 4.0" x 0.125"	Light Beige	FT	
	9685-TUBE-19-AL	2.0" x 4.0" x 0.125"	Bronze	FT	
	9686-TUBE-22-AL	2.0" x 4.0" x 0.125"	Dark Brown	FT	

Sold in 20 ft Lengths

All other Rollac standard colors are available upon request.

### Rectangular Tubes - 3.0" x 4.0" x 0.125"

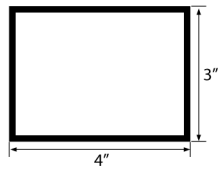
	Part Number	Description	Color	Unit	Note
	9687-TUBE-06-AL	3.0" x 4.0" x 0.125"	White	FT	
	9688-TUBE-19-AL	3.0" x 4.0" x 0.125"	Bronze	FT	
	9689-TUBE-23-AL	3.0" x 4.0" x 0.125"	Millfinish	FT	
	9791-TUBE-02-AL	3.0" x 4.0" x 0.125"	Anodized Silver	FT	
	9697-TUBE-04-AL	3.0" x 4.0" x 0.125"	Cream	FT	

Sold in 20 ft Lengths

All other Rollac standard colors are available upon request.

### Square Tubes - 2.0" x 2.0" x 0.125"

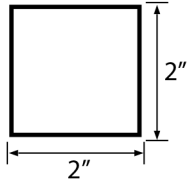
	Part Number	Description	Color	Unit	Note
	9669-TUBE-04-AL	2.0" x 2.0" x 0.125"	Cream	FT	
	9670-TUBE-06-AL	2.0" x 2.0" x 0.125"	White	FT	
	9672-TUBE-13-AL	2.0" x 2.0" x 0.125"	Light Beige	FT	
	9673-TUBE-19-AL	2.0" x 2.0" x 0.125"	Bronze	FT	
	9674-TUBE-23-AL	2.0" x 2.0" x 0.125"	Millfinish	FT	

Sold in 20 ft Lengths

All other Rollac standard colors are available upon request.

### Square Tubes - 4.0" x 4.0" x 0.125"

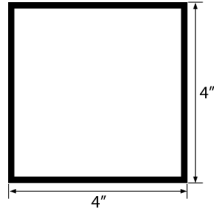
	Part Number	Description	Color	Unit	Note
	9690-TUBE-19-AL	4.0" x 4.0" x 0.125"	Bronze	FT	!
	9700-TUBE-06-AL	4.0" x 4.0" x 0.125"	White	FT	!

Sold in 20 ft Lengths

\* - Typically ships within 3 days  
 N - New item  
 ! - Special order item